

ZX1

ZX1-100
8-Inch Two-Way,
100° x 100° Indoor/Outdoor
Portable Loudspeaker System



Key Features:

- Extremely Smooth, Wide Frequency Response
- Attractive, Clean Design with Full Grille
- EV8L 8" High-Output LF Transducer
- DH2005 1" Exit True Compression Driver
- 100° x 100° Coverage Pattern
- Rotatable Horn Design
- Integral Monitor Angle on Enclosure
- 200W Cont., 800W Peak Power Handling
- High Sensitivity, 121 dB Maximum SPL
- Built-In Pole Mount
- Integral Handle Pocket for Easy Carrying



General Description:

The Electro-Voice® ZX1 is the new standard of no compromise audio performance and versatility for compact sound reinforcement.

The high-tech enclosure uses injection-molded high-impact polypropylene to make the ZX1 extremely durable. The enclosure geometry has been engineered to provide maximum rigidity and acoustic performance. The velocity compensated port design overcomes the limitation of many small loudspeakers and enables exceptional low frequency response without vent noise.

The ZX1's long excursion, high output 8" woofer with a weatherized treated cone delivers smooth low frequency performance with exceptional reliability. A sophisticated crossover network integrates it with the DH2005, a 1.25" voice coil titanium diaphragm true compression driver for maximum output with extended frequency response. Full-bandwidth overload protection is provided for reliable, long term operation without audible effect.

The horn features 100° x 100° coverage, allowing the ZX1 to be oriented either horizontally or vertically for the ultimate in coverage flexibility.

The ZX1's molded polymer enclosure is inherently water resistant. The enclosure features an integrated pole mount, a pocket handle, and a wedge-angle design allowing for use as a stage monitor.

Technical Specifications:

Freq. Response ¹ (-3 dB):	60 Hz - 20 kHz
Freq. Range ¹ (-10 dB):	48 Hz - 20 kHz
Rec. Hipass Frequency:	40 Hz
Axial Sensitivity ¹ :	92 dB (1W/1m)
Max Calculated SPL:	121 dB
Horizontal Coverage:	100°
Vertical Coverage:	100°
Rated System Power:	200W Cont. ² , 400W Prog., 800W Peak
LF Transducer:	EV8L, 8 in (203mm) Driver
HF Transducer:	DH2005, 1 in. (25.4mm) Exit Compression Driver
Crossover Frequency:	1.7 kHz
Nominal Impedance:	8 Ohms
Minimum Impedance:	6 Ohms
Connectors:	Neutrik Speakon NL4
Enclosure Material:	High Impact Polymer
Grille:	Polyester Powder Coated, 18GA Galvanized Steel
Dim (H x W x D):	457mm x 282mm x 264mm (17.98" x 11.12" x 10.38")
Net Weight:	8.4 kg (18.5 lbs)
Shipping Weight:	10.2 kg (22.5 lbs)

¹ Half Space Measurement.

² IEC Noise, 6 dB Crest Factor.

Dimension Drawings:

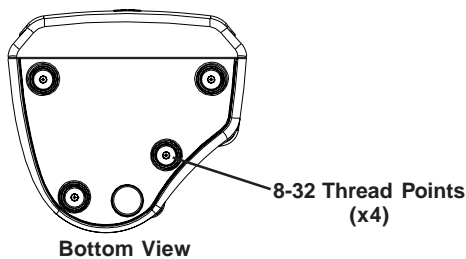
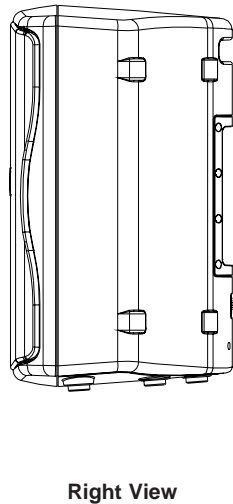
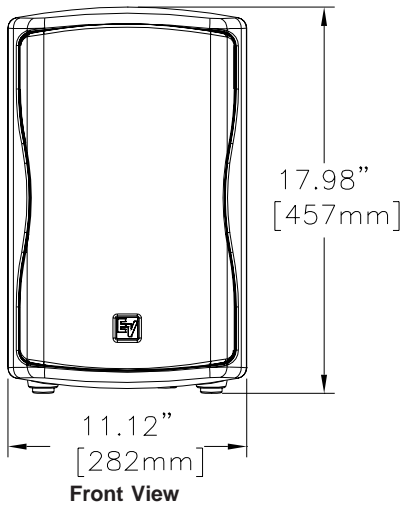
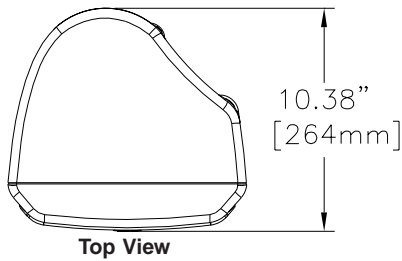

Block Diagram:

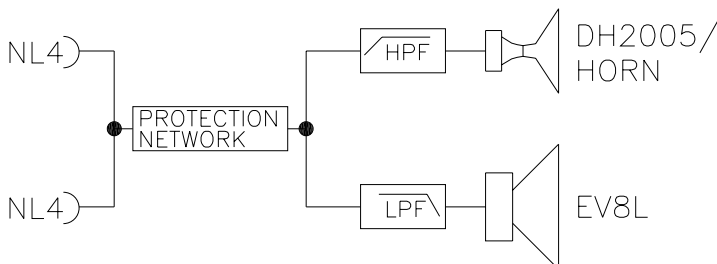

Frequency Response & Impedance:

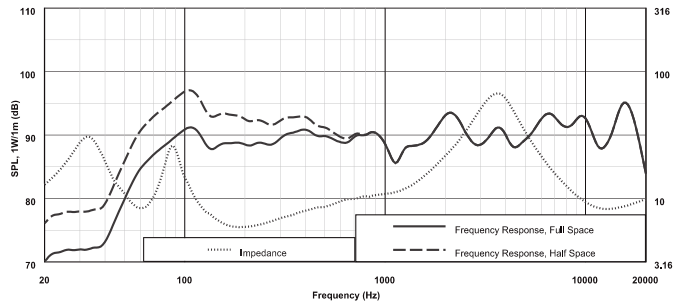

Beamwidth:

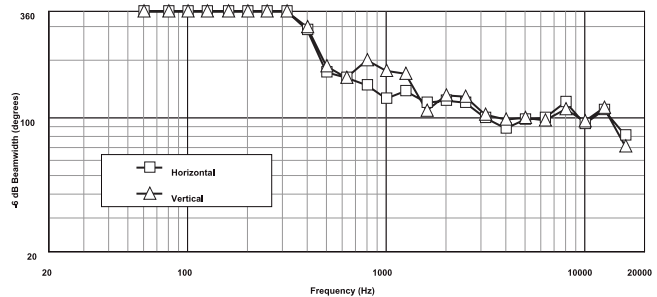

ZX1-100 Part Numbers

- 301850-003 ZX1-100, 100° x 100° Horn, Black Finish
- 301850-004 ZX1-100, 100° x 100° Horn, White Finish

Performance Match

- 301576-001 SbA760, 120V 15" Powered Subwoofer, 760W
- D170259 CP1800, 120V Power Amplifier, 2 x 600W
- D170258 CP2200, 120V Power Amplifier, 2 x 800W

Accessories

- 301916-001 MP1-B, Mounting Plate Kit, Black
- 301917-001 CB1, Carrying Bag, Convertible, Black
- 301919-001 SC-ZX1, Slip Cover for ZX1, Black
- 302023-001 CA-ZX, Truss Clamp Adapter for ZX1
- 593717 100BK, Tripod Speaker Stand

CAUTION

This ZX1 Loudspeaker should be suspended overhead only in accordance with the procedures and limitations specified. This system should be suspended with certified rigging hardware by an authorized rigging professional and in compliance with local, state, and federal overhead suspension ordinances.

EV Electro-Voice®

12000 Portland Avenue South, Burnsville, MN 55337

Phone: 952/884-4051, Fax: 952/884-0043

www.electrovoice.com

© Telex Communications, Inc. 5/2006

Part Number LIT000001 Rev. A

U.S.A. and Canada only. For customer orders, contact Customer Service at:

800/392-3497 Fax: 800/955-6831

Europe, Africa, and Middle East only. For customer orders, contact Customer Service at:

+ 49 9421-706 0 Fax: + 49 9421-706 265

Other International locations. For customer orders, contact Customer Service at:

+ 1 952 884-4051 Fax: + 1 952 736-4212

For warranty repair or service information, contact the Service Repair department at:

800/685-2606

For technical assistance, contact Technical Support at: **866/78AUDIO**

Specifications subject to change without notice.